



S6 Automation Module

Legal Notices

© 2013 Avid Technology, Inc., ("Avid"), all rights reserved. This guide may not be duplicated in whole or in part without the written consent of Avid.

003, 192 Digital I/O, 192 I/O, 96 I/O, 96i I/O, Adrenaline, AirSpeed, ALEX, Alienbrain, AME, AniMatte, Archive, Archive II, Assistant Station, AudioPages, AudioStation, AutoLoop, AutoSync, Avid, Avid Active, Avid Advanced Response, Avid DNA, Avid DNxcel, Avid DNxHD, Avid DS Assist Station, Avid Ignite, Avid Liquid, Avid Media Engine, Avid Media Processor, Avid MEDIArray, Avid Mojo, Avid Remote Response, Avid Unity, Avid Unity ISIS, Avid VideoRAID, AvidRAID, AvidShare, AVIDStripe, AVX, Beat Detective, Beauty Without The Bandwidth, Beyond Reality, BF Essentials, Bomb Factory, Bruno, C|24, CaptureManager, ChromaCurve, ChromaWheel, Cineractive Engine, Cineractive Player, Cineractive Viewer, Color Conductor, Command8, Controll24, Cosmonaut Voice, Countdown, d2, d3, DAE, D-Command, D-Control, Deko, DekoCast, D-Fi, D-fx, Digi 002, Digi 003, DigiBase, Digidesign, Digidesign Audio Engine, Digidesign Development Partners, Digidesign Intelligent Noise Reduction, Digidesign TDM Bus, DigiLink, DigiMeter, DigiPanner, DigiProNet, DigiRack, DigiSerial, DigiSnake, DigiSystem, Digital Choreography, Digital Nonlinear Accelerator, DigiTest, DigiTranslator, DigiWear, DINR, DNxchange, Do More, DPP-1, D-Show, DSP Manager, DS-StorageCalc, DV Toolkit, DVD Complete, D-Verb, Eleven, EM, Euphonix, EUCON, EveryPhase, Expander, ExpertRender, Fairchild, FastBreak, Fast Track, Film Cutter, FilmScribe, Flexevent, FluidMotion, Frame Chase, FXDeko, HD Core, HD Process, HDpack, Home-to-Hollywood, HyperSPACE, HyperSPACE HDCAM, iKnowledge, Impact, Improv, iNEWS, iNEWS Assign, iNEWS ControlAir, InGame, Instantwrite, Instinct, Intelligent Content Management, Intelligent Digital Actor Technology, IntelliRender, Intelli-Sat, Intelli-Sat Broadcasting Recording Manager, InterFX, Interplay, inTONE, Intraframe, iS Expander, iS9, iS18, iS23, iS36, ISIS, IsoSync, LaunchPad, LeaderPlus, LFX, Lightning, Link & Sync, ListSync, LKT-200, Lo-Fi, MachineControl, Magic Mask, Make Anything Hollywood, make manage move|media, Marquee, MassivePack, MassivePack Pro, Maxim, Mbox, Media Composer, MediaFlow, MediaLog, MediaMix, Media Reader, Media Recorder, MEDIArray, MediaServer, MediaShare, MetaFuze, MetaSync, MIDI I/O, Mix Rack, Moviestar, MultiShell, NaturalMatch, NewsCutter, NewsView, NewsVision, Nitris, NL3D, NLP, NSDOS, NSWIN, OMF, OMF Interchange, OMM, OnDVD, Open Media Framework, Open Media Management, Painterly Effects, Palladium, Personal Q, PET, Podcast Factory, PowerSwap, PRE, ProControl, ProEncode, Profiler, Pro Tools, Pro Tools|HD, Pro Tools LE, Pro Tools M-Powered, Pro Transfer, QuickPunch, QuietDrive, Realtime Motion Synthesis, Recti-Fi, Reel Tape Delay, Reel Tape Flanger, Reel Tape Saturation, Reprise, Res Rocket Surfer, Reso, RetroLoop, Reverb One, ReVibe, Revolution, rS9, rS18, RTAS, Salesview, Sci-Fi, Scorch, ScriptSync, SecureProductionEnvironment, Shape-to-Shape, ShuttleCase, Sibelius, SimulPlay, SimulRecord, Slightly Rude Compressor, Smack!, Soft SampleCell, Soft-Clip Limiter, SoundReplacer, SPACE, SPACESHift, SpectraGraph, SpectraMatte, SteadyGlide, Streamfactory, Streamgenie, StreamRAID, SubCap, Sundance, Sundance Digital, SurroundScope, Symphony, SYNC HD, SYNC I/O, Synchronic, SynchroScope, Syntax, TDM FlexCable, TechFlix, Tel-Ray, Thunder, TimeLiner, Titansync, Titan, TL Aggro, TL AutoPan, TL Drum Rehab, TL Everyphase, TL Fauxlder, TL In Tune, TL MasterMeter, TL Metro, TL Space, TL Utilities, tools for storytellers, Transit, TransJammer, Trillium Lane Labs, TruTouch, UnityRAID, Vari-Fi, Video the Web Way, VideoRAID, VideoSPACE, VTEM, Work-N-Play, Xdeck, X-Form, and XMON are either registered trademarks or trademarks of Avid Technology, Inc. in the United States and/or other countries.

Bonjour, the Bonjour logo, and the Bonjour symbol are trademarks of Apple Computer, Inc.

Thunderbolt and the Thunderbolt logo are trademarks of Intel Corporation in the U.S. and/or other countries.

This product may be protected by one or more U.S. and non-U.S. patents. Details are available at www.avid.com/patents.

Product features, specifications, system requirements, and availability are subject to change without notice..

Guide Part Number 9329-65270-00 REV A 12/13

Contents

- Chapter 1. Introduction** 1
 - Module Capabilities and Features 1
 - System Requirements and Compatibility 2
 - Registration 2
 - About www.avid.com 2

- Chapter 2. S6 Automation Module Connections** 3
 - Connecting a Single Module 3

- Chapter 3. S6 Automation Module Overview** 4
 - Top Panel Controls and Displays 5

- Appendix A. Specifications** 11
 - Mechanical 11
 - Environmental 11
 - Dimensions 12

- Appendix B. Compliance Information** 13
 - Environmental Compliance 13
 - EMC (Electromagnetic Compliance) 14
 - Safety Compliance 15

Chapter 1: Introduction

The Avid® S6 Automation Module is the transport and automation master section module. It provides switches for time code and transport operations, a Jog wheel, a numeric keypad, two banks of Soft Keys, and a fader strip.

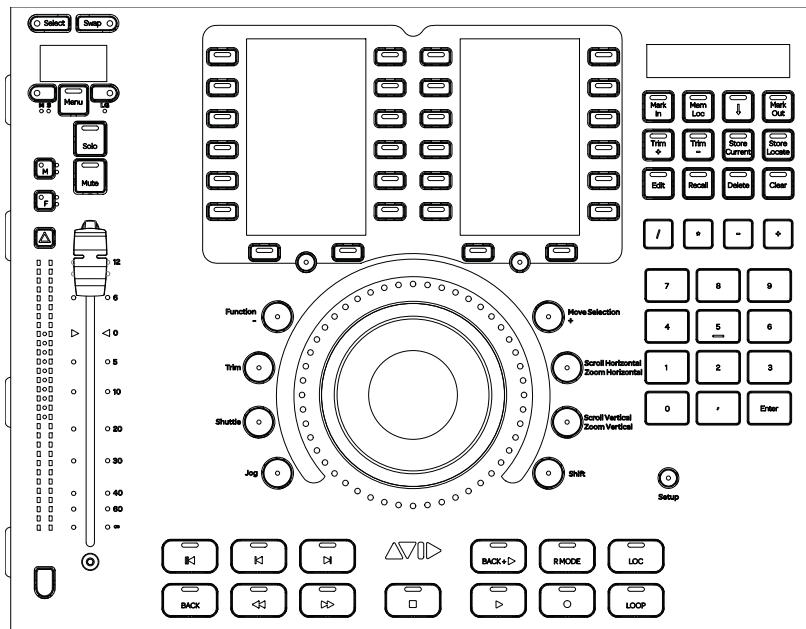

Automation Module

Module Capabilities and Features

- 1 (one) fader strip
- 1 (one) Jog/Shuttle Wheel with Wheel mode switches
- Transport switches
- Numeric Keypad
- 2 (two) banks of Soft Key, each with high resolution TFT display
- Setup switch
- Timecode and Locate display and controls
- 2-pin 12V Power
- 1000-BaseT (Gigabit) Ethernet RJ45 connector

System Requirements and Compatibility

Avid can only assure compatibility and provide support for hardware and software it has tested and approved.

For complete system requirements and a list of qualified computers, operating systems, hard drives, and third-party devices, visit:
www.avid.com/compatibility

Registration

Review the enclosed Registration Information Card and follow the instructions on it to register your purchase online.

By registering, you become eligible to receive the following:

- Technical support information
- Software update and upgrade notices
- Hardware warranty information

About www.avid.com

The Avid website (www.avid.com) is your best online source for information to help you get the most out of your Pro Tools system. The following are just a few of the services and features available.

Product Registration Register your purchase online.

Support and Downloads Contact Avid Customer Success (technical support); download software updates and the latest online manuals; browse the Compatibility documents for system requirements; search the online Knowledge Base or join the worldwide Pro Tools community on the User Conference.

Training and Education Study on your own using courses available online or find out how you can learn in a classroom setting at a certified Pro Tools training center.

Products and Developers Learn about Avid products; download demo software or learn about our Development Partners and their plug-ins, applications, and hardware.

News and Events Get the latest news from Avid or sign up for a demo.

Chapter 2: S6 Automation Module Connections

Connecting a Single Module

Connectors for power and Ethernet are located along the side of the module.

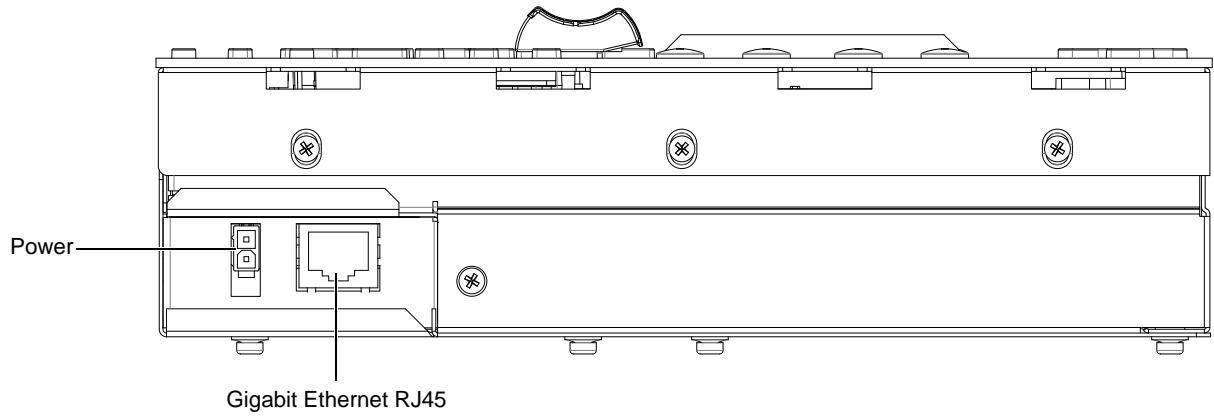

The Automation Module is powered by 12 V DC. The power input connector is a 2-conductor Molex.

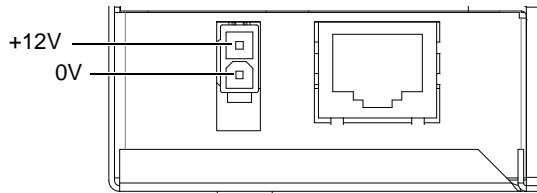

Chapter 3: S6 Automation Module Overview

This chapter identifies the hardware features on the Automation Module.

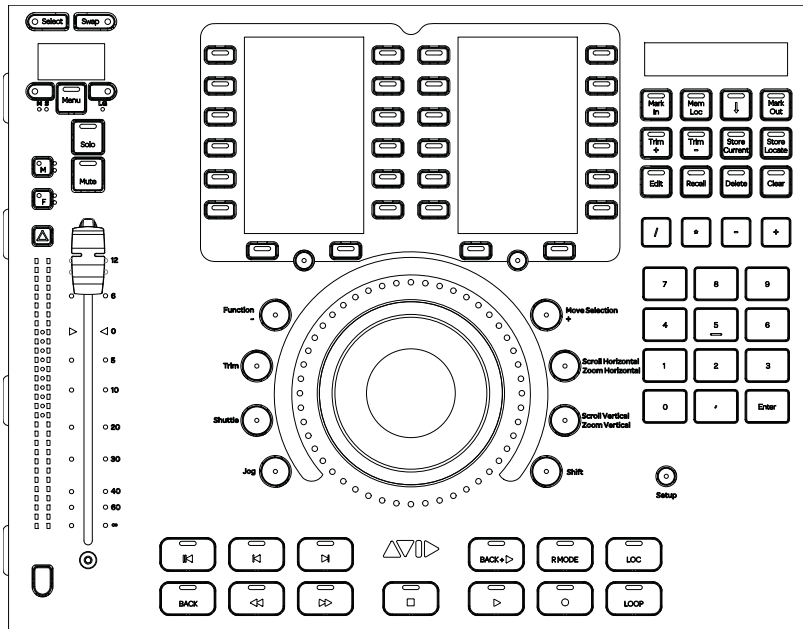

Automation Module

Top Panel Controls and Displays

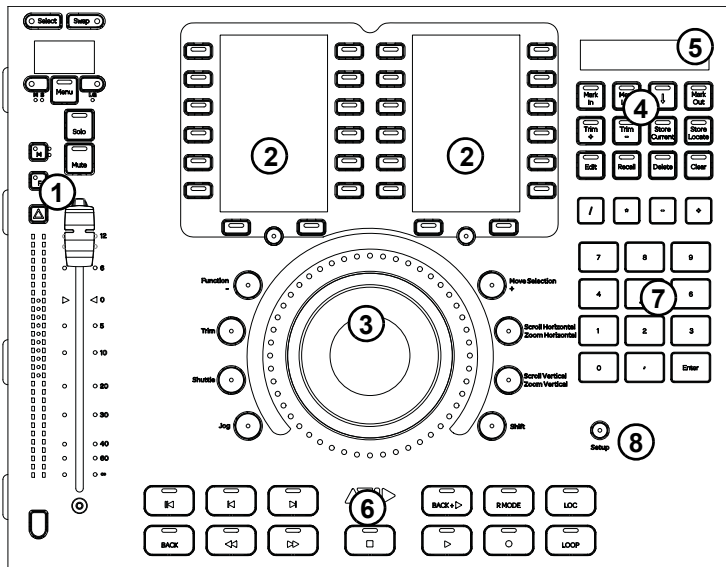

Automation Module

Main Sections

1. Attention Track Fader
2. Soft Keys
3. Jog Wheel
4. Locate Controls
5. Timecode Display
6. Transport Controls
7. Numeric Keypad
8. Setup

1. Attention Track Fader

The Attention Fader provides a fader strip with dual LED meters, controls and displays.

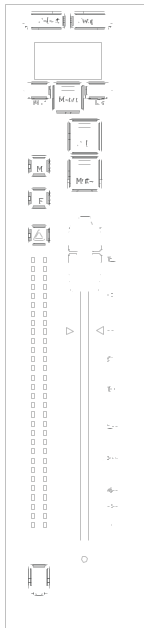

Channel Fader and Meters

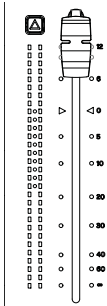

Track Color/Modifier Switch

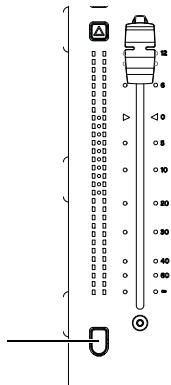

Attention Key

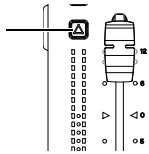

Automation Punch

The Attention Track provides two Automation Punch switches **F** and **M**, each with two Automation Indicator LEDs.

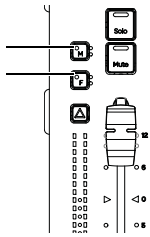

Mute and Solo Switches

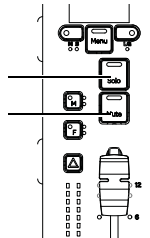

OLED (Display)

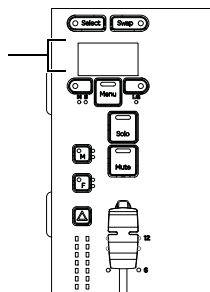

Menu Switches

Menu switches include Menu Left, Menu, and Menu Down.

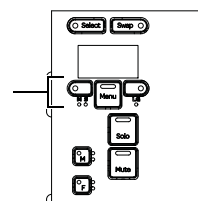

Master, Slave, and Link Indicators

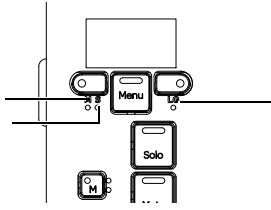

Select and Swap

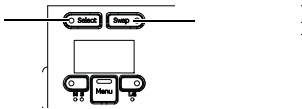

Select Selects the currently attentioned track or adds it to the current selection.

Swap This control is not implemented.

2. Soft Keys

The Automation Module provides two, 12-key Soft Key banks, each with three additional Soft Keys below, and its own high resolution TFT display. Each display is surrounded by two columns of switches for selecting assigned Soft Keys.

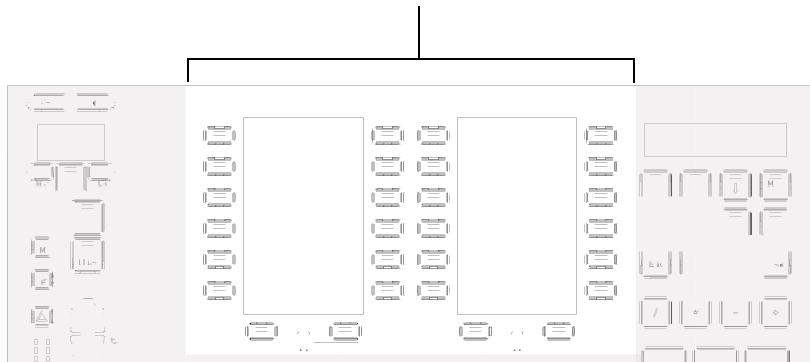

The keys across the bottom default to navigating to display different banks of Soft Keys. Switch functions appear along the bottom of each Soft Key display, directly above each corresponding switch.



3. Jog Wheel with Mode Switches

The Jog Wheel can be assigned to many functions by enabling one of the Jog Wheel Mode switches. An LED ring surrounding the Jog Wheel indicates wheel position and other values, depending on the current function of the wheel. The **Shift** key at the lower right of the Mode Switches lets you access the **Shift** (secondary) function of any Jog Wheel Mode switch.

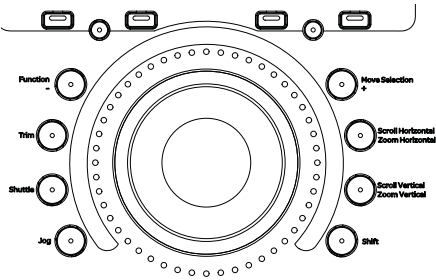

The Jog Wheel provides the following switches that determine the function of the wheel (as available on the current DAW).

Jog

Shuttle

Trim

Function / -

Move Selection / +

Scroll Horizontal / Zoom Horizontal

Scroll Vertical / Zoom Vertical

Shift

4. Locate Controls



5. Timecode Display

Above the Locate Controls is the two-row Timecode display.



6. Transport



The following switches are provided in the Transport section:

- ||◀ (RTZ), |◀ (previous), ▶| (next), **BACK+▶**, **RMODE**, **LOC**
- **BACK**, ◀◀ (REW), ▶▶ (FWD), **STOP**, **PLAY**, **REC**, **LOOP**

7. Numeric Keypad

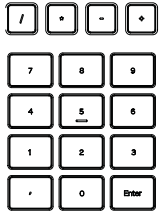

8. Setup

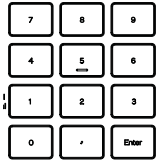

Appendix A: Specifications

Mechanical

Avid S6 Automation Module Mechanical Specifications

Parameter	Specification
Dimensions (L x W x D)	8.9 x 11.6 x 2.4 inches (+ 0.7 inches including knobs) 224 x 294 x 60 mm (+ 17mm including knobs)
Weight	5.02 lbs (2.28 kg)
Power Requirements	12 VDC, 1.5 A
Ethernet Ports (2)	1000-BaseT (Gigabit) Ethernet RJ-45

Environmental

Avid S6 Automation Module Environmental Specifications

Parameter	Specification	Limit	Units	Condition/Comment
Storage Temperature	-18 to +60 deg C		deg C	0 to +140 deg F
Operating Temperature	+4 to +40 deg C		deg C	+40 to +104 deg F
Storage humidity range	5 to 95		%	Non-condensing
Operating Humidity Range	20 to 80		%	Non-condensing
Continuous Vibration (Storage only: non-powered transportation)	1		g RMS	Random spectrum

Dimensions

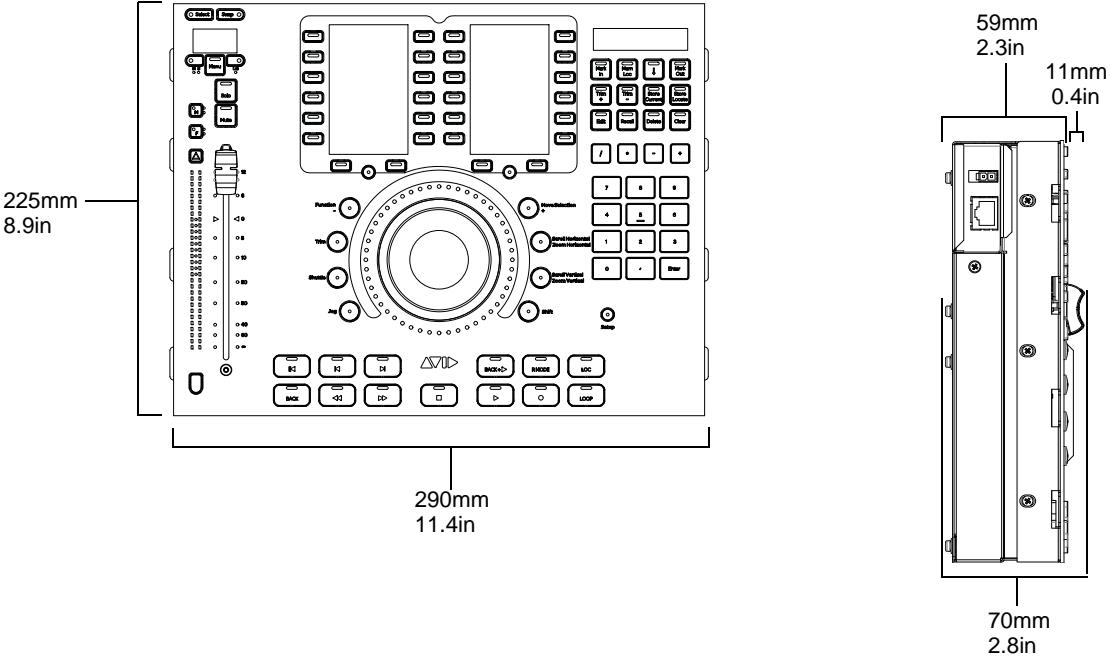

Appendix B: Compliance Information

Environmental Compliance

Disposal of Waste Equipment by Users in the European Union



This symbol on the product or its packaging indicates that this product must not be disposed of with other waste. Instead, it is your responsibility to dispose of your waste equipment by handing it over to a designated collection point for the recycling of waste electrical and electronic equipment. The separate collection and recycling of your waste equipment at the time of disposal will help conserve natural resources and ensure that it is recycled in a manner that protects human health and the environment. For more information about where you can drop off your waste equipment for recycling, please contact your local city recycling office or the dealer from whom you purchased the product.

Proposition 65 Warning

▲ *This product contains chemicals, including lead, known to the State of California to cause cancer and birth defects or other reproductive harm. Wash hands after handling.*

Perchlorate Notice

This product may contain a lithium coin battery. The State of California requires the following disclosure statement: “Perchlorate Material – special handling may apply, See [www.dtsc.ca.gov/hazardous waste/perchlorate](http://www.dtsc.ca.gov/hazardous%20waste/perchlorate).”

Recycling Notice



EMC (Electromagnetic Compliance)

Avid declares that this product complies with the following standards regulating emissions and immunity:

- FCC Part 15 Class B
- EN 55022 Class B
- AS/NZS CISPR 22 Class B
- CISPR 22 Class B
- EN 55103-1, Class E2 and E3
- EN 55103-2, Class E2 and E3

FCC Compliance for United States

Communication Statement

NOTE: This equipment has been tested and found to comply with the limits for a Class B digital device, pursuant to Part 15 of the FCC Rules. These limits are designed to provide reasonable protection against harmful interference in a residential installation. This equipment generates, uses, and can radiate radio frequency energy and, if not installed and used in accordance with the instructions, may cause harmful interference to radio communications. However, there is no guarantee that interference will not occur in a particular installation. If this equipment does cause harmful interference to radio or television reception, which can be determined by turning the equipment off and on, the user is encouraged to try and correct the interference by one or more of the following measures:

- Reorient or locate the receiving antenna.
- Increase the separation between the equipment and receiver.
- Connect the equipment into an outlet on a circuit different from that to which the receiver is connected.
- Consult the dealer or an experienced radio/TV technician for help.

Any modifications to the unit, unless expressly approved by Avid, could void the user's authority to operate the equipment.

Australian Compliance



Canadian Compliance

This Class B digital apparatus meets all requirements of the Canadian Interference-Causing Equipment Regulations.

Cet appareil numérique de la classe B respecte toutes les exigences du Règlement sur le matériel brouilleur du Canada.

CE Compliance

(EMC and Safety)



Avid is authorized to apply the CE (Conformité Européenne) mark on this compliant equipment thereby declaring conformity to EMC Directive 2004/108/EC and Low Voltage Directive 2006/95/EC.

Safety Compliance

Safety Statement

This equipment has been tested to comply with USA and Canadian safety certification in accordance with the specifications of UL Standards: UL 60065 7th Ed., 2007-12-11, CAN/CSA C22.2 No. 60065-03, 1st Ed, 2006-04 +A1:2006, EN 60065:2002 + A1:2006 + A11:2008, IEC 60065:2001 + A1:2005 + A2:2010.

Avid Technology Inc., has been authorized to apply the appropriate NRTL mark on its compliant equipment.

Korea Class B EMC Compliance

이 기기는 가정용 (B 급) 전자파적합기기로서 주로 가정에서 사용하는 것을 목적으로 하며, 모든 지역에서 사용할 수 있습니다.

Warning



Important Safety Instructions

- 1) Read these instructions.
- 2) Keep these instructions.
- 3) Heed all warnings.
- 4) Follow all instructions.
- 5) Do not use this equipment near water.
- 6) Clean only with dry cloth.
- 7) Do not block any ventilation openings. Install in accordance with the manufacturer's instructions.
- 8) Do not install near any heat sources such as radiators, heat registers, stoves, or other equipment (including amplifiers) that produce heat.
- 10) Protect power cords from being walked on or pinched particularly at plugs, convenience receptacles, and the point where they exit from the equipment.
- 11) Only use attachments/accessories specified by the manufacturer.
- 12) For products that are not rack-mountable: Use only with a cart, stand, tripod, bracket, or table specified by the manufacturer, or sold with the equipment. When a cart is used, use caution when moving the cart/equipment combination to avoid injury from tip-over.
- 13) Unplug this equipment during lightning storms or when unused for long periods of time.
- 14) Refer all servicing to qualified service personnel. Servicing is required when the equipment has been damaged in any way, such as power-supply cord or plug is damaged, liquid has been spilled or objects have fallen into the equipment, the equipment has been exposed to rain or moisture, does not operate normally, or has been dropped.

15) For products that are a Mains powered device:

The equipment shall not be exposed to dripping or splashing and no objects filled with liquids (such as vases) shall be placed on the equipment.

Warning! To reduce the risk of fire or electric shock, do not expose this equipment to rain or moisture.

Do not defeat the safety purpose of the polarized or grounding-type plug. A polarized plug has two blades with one wider than the other. A grounding type plug has two blades and a third grounding prong. The wide blade or the third prong are provided for your safety. If the provided plug does not fit into your outlet, consult an electrician for replacement of the obsolete outlet.

16) For products containing a lithium battery:

CAUTION! Danger of explosion if battery is incorrectly replaced. Replace only with the same or equivalent type.

17) For products with a power switch:

It should remain accessible after installation.

18) The equipment shall be used at a maximum ambient temperature of 40° C.

19) This unit is provided with a power supply cord set suitable for 120V AC input only (for U.S.A. and Canada). For other than U.S.A. and Canada, a qualified person must provide for use with this unit, an appropriate, approved power supply cord set which is in compliance with the end use country requirements and has a minimum cross-sectional area of 1.0mm².

20) For products with more than one power cord:

CAUTION: This unit has more than one power supply cord. Disconnect two power supply cords before servicing to avoid electrical shock.

ATTENTION: Cet appareil comporte plus d'un cordon d'alimentation. Afin de prévenir les chocs électriques, débrancher les deux cordons d'alimentation avant de faire le dépannage.

21) For products with an operator-accessible fuse:

CAUTION: For continued protection against risk of fire, replace only with same type and rating of fuse.

ATTENTION: Pour ne pas compromettre la protection contre les risques d'incendie, remplacer par un fusible de même type et de même caractéristiques nominales.



Avid
2001 Junipero Serra Boulevard
Daly City, CA 94014-3886 USA

Technical Support (USA)
Visit the Online Support Center at
www.avid.com/support

Product Information
For company and product information,
visit us on the web at www.avid.com